

TI Designs: TIDA-01423

3V~4.5V入力、400mA、-12V反転昇降圧リファレンス・デザイン



概要

TIDA-01423 TI Designでは、反転昇降圧コンバータ(電圧インバータ)を使用して、3V~4.5Vの入力電圧から、電流400mAの-12Vレールを生成する方法を紹介します。このような負の電圧は、多くの通信機器システムに加えて、テストおよび測定用などの産業用機器に必要とされます。

TPS62136降圧コンバータにより、非常に単純な負電圧インバータ(反転昇降圧)設計を使用して、電流400mAで12Vの負の出力電圧を作り出すことができます。

リソース

TIDA-01423

デザイン・フォルダ

TPS62136

プロダクト・フォルダ



E2Eエキスパートに質問

特長

- -12Vの高い負の出力電圧
- ソリューションの合計サイズは65mm²未満
- 400mAの高い出力電流
- 低い出力電圧リップル(0.5%未満)
- 3V~4.5Vの入力電圧範囲

アプリケーション

- 通信インフラストラクチャ
- ワイヤレス・インフラストラクチャ
- 光モジュール
- 光ネットワーク: EPON
- リモート無線ユニット(RRU)

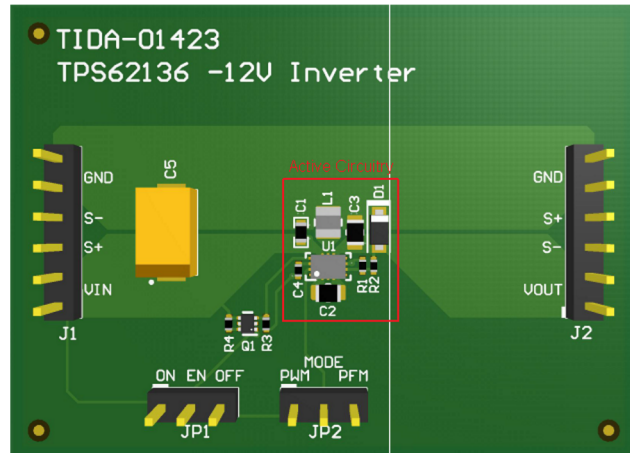
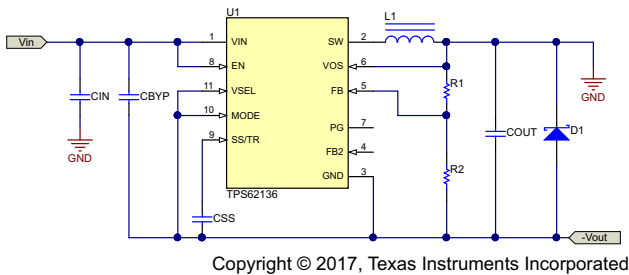

使用許可、知的財産、その他免責事項は、最終ページにあるIMPORTANT NOTICE(重要な注意事項)をご参照くださいますようお願いいたします。英語版のTI製品についての情報を翻訳したこの資料は、製品の概要を確認する目的で便宜的に提供しているものです。該当する正式な英語版の最新情報は、www.ti.comで閲覧でき、その内容が常に優先されます。TIでは翻訳の正確性および妥当性につきましては一切保証いたしません。実際の設計などの前には、必ず最新版の英語版をご参照くださいますようお願いいたします。

1 System Description

A negative voltage in the range of -5 V to -12 V is frequently required in high-performance communications equipment systems, such as optical modules and remote radio units.

In an optical module, the negative voltage is required to supply modulators like the electroabsorption modulator (EAM) or Mach-Zehnder modulator (MZM). The high efficiency (low temperature rise) and small size is very important in such systems.

Such high negative voltages are also required for the new Gallium Nitride (GaN) technology (field-effect transistor (FET) and RF power amplifier) used in antenna systems and remote radio units.

The wide-output voltage range supports many of the different voltages required in such systems, which enables the same design to be reused for different systems that have different negative voltage rails.

1.1 Key System Specifications

表 1. Key System Specifications

PARAMETERS	SPECIFICATIONS	DETAILS
Input voltage range (V_{IN})	3 V to 4.5 V	—
Output voltage (V_{OUT})	-12 V	—
Output current	0.4 A	☒ 4

2 System Overview

2.1 Highlighted Products

2.1.1 TPS62136

The TPS62136 is a 4-A, step-down converter in a 2x3-mm QFN package based on a distributed control system (DCS). The device accepts up to a 17-V input voltage and supports up to 12 V on its output. This wide-input voltage range is ideally suited for an inverting converter, which, at a minimum, requires a voltage rating of the input voltage plus the output voltage.

2.2 Design Considerations

2.2.1 Inverting Buck-Boost Topology Concept

The inverting buck-boost topology is very similar to the buck topology. In the buck configuration that [Figure 1](#) shows: the positive connection (V_{OUT}) is connected to the inductor and the return connection is connected to the ground (GND) pin of the integrated circuit (IC). However, in the inverting buck-boost configuration that [Figure 2](#) shows, the IC ground is used as the negative output voltage pin (labeled as $-V_{OUT}$). The former positive output in the buck configuration is used as the ground. This inverting topology allows the output voltage to be inverted and always lower than the ground.

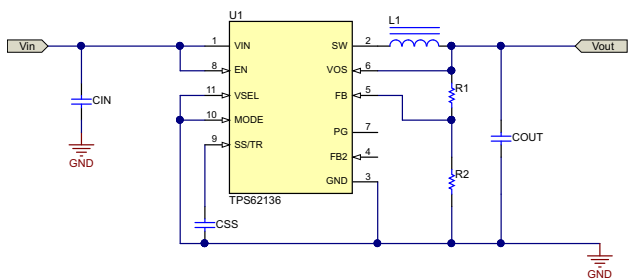

Copyright © 2017, Texas Instruments Incorporated

[Figure 1](#). TPS62136 Buck Topology

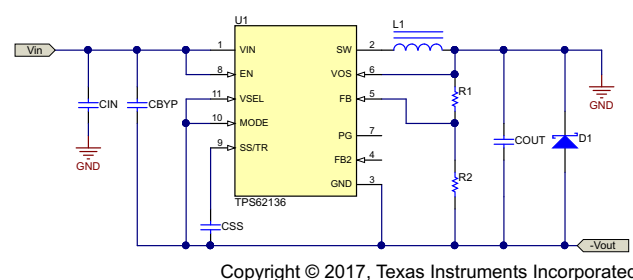

Copyright © 2017, Texas Instruments Incorporated

[Figure 2](#). TPS62136 Inverting Buck-Boost Topology

The circuit operation is different in the inverting buck-boost topology than in the buck topology. [Figure 3 \(a\)](#) shows that the output voltage terminals are reversed, though the components are wired the same as a buck converter. As [Figure 3 \(b\)](#) shows, during the ON-time of the control MOSFET, the inductor is charged with current while the output capacitor supplies the load current. The inductor does not provide current to the load during this time. During the OFF-time of the control MOSFET and the ON-time of the synchronous MOSFET shown in [Figure 3 \(c\)](#), the inductor provides current to the load and the output capacitor. These changes affect many parameters, which the following subsections describe in further detail.



図 3. Inverting Buck-Boost Configuration

The average inductor current is affected in this topology. In the buck configuration, the average inductor current is equal to the average output current because the inductor always supplies current to the load during both the ON- and OFF-times of the control MOSFET. However, in the inverting buck-boost configuration, only the output capacitor supplies the load with current, while the load is completely disconnected from the inductor during the ON-time of the control MOSFET. During the OFF-time, the inductor connects to both the output capacitor and the load (see 図 3). Because the OFF-time is $1 - D$ of the switching period, the average inductor current in 式 1 is calculated as:

$$I_{L(Avg)} = \left| \frac{I_{OUT}}{(1-D)} \right| \quad (1)$$

The duty cycle for the typical buck converter is simply V_{OUT} / V_{IN} , but the calculation of the ideal duty cycle in 式 2 for an inverting buck-boost converter becomes:

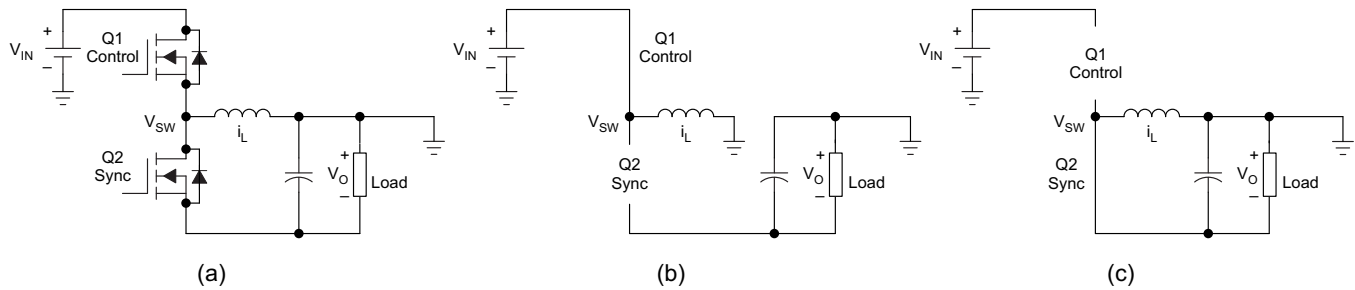
$$D = \frac{V_{OUT}}{(V_{OUT} - V_{IN})} \quad (2)$$

式 3 provides the peak-to-peak inductor ripple current:

$$\Delta I_L = \frac{V_{IN} D}{f_s L} \quad (3)$$

where,

- ΔI_L (A): Peak-to-peak inductor ripple current
- D: Duty cycle
- f_s (MHz): Switching frequency
- L (μ H): Inductor value
- V_{IN} (V): Input voltage with respect to ground, not with respect to the device ground or V_{OUT} .

式 4 calculates the maximum inductor current:

$$I_L = I_{L(avg)} + \frac{\Delta I_L}{2} \quad (4)$$

2.2.2 V_{IN} and V_{OUT} Range

The input voltage that can be applied to an integrated circuit (IC) operating in the inverting buck-boost topology is less than the input voltage for the same IC operating in the buck topology. The reason for this difference is because the ground pin of the IC is connected to the (negative) output voltage. Therefore, the input voltage across the device is V_{IN} to V_{OUT} , not V_{IN} to ground. Thus, the input voltage range of the TPS62136 is 3 V to 17 V + V_{OUT} , where V_{OUT} is a negative value.

The output voltage range is the same as when configured as a buck converter, but negative. The output voltage for the inverting buck-boost topology must be set between -0.8 V and -12 V . The output voltage is set in the same way as the buck configuration, with two resistors connected to the FB pin. The TIDA-01423 design sets the output voltage at -12 V , which gives an input voltage range of 3 V to 5 V . However, TI does not recommend to use a 5-V input voltage because voltage tolerances on the input supply can violate the recommended operating range of TPS62136.

2.2.3 Capacitor Selection

An input capacitor, C_{IN} , is required to provide a low-impedance input voltage source to the inverter. A low equivalent series resistance (ESR) X5R or X7R ceramic capacitor is best for input voltage filtering and minimizing interference with other circuits. For most applications, a $10\text{-}\mu\text{F}$ ceramic capacitor is recommended from V_{IN} to ground (system ground, not $-V_{\text{OUT}}$). The C_{IN} capacitor value can be increased without any limit for better input voltage filtering.

On the output, the TIDA-01423 design uses a $22\text{-}\mu\text{F}$ output capacitor, which has an effective capacitance of about $10\text{ }\mu\text{F}$ at the -12-V output voltage. For maximum output current, a second output capacitor can help to increase the phase margin.

For the inverting buck-boost configuration of the TPS62136, installing a bypass capacitor, CBYP, to provide a low impedance source for the internal gate drivers is important. This capacitor is connected from V_{IN} to $-V_{\text{OUT}}$; therefore, it requires the highest voltage rating. For most applications, a $22\text{-}\mu\text{F}$ ceramic capacitor is recommended. The bypass capacitor provides an AC path from V_{IN} to $-V_{\text{OUT}}$. When V_{IN} is applied to the circuit, this dV/dt across a capacitor from V_{IN} to $-V_{\text{OUT}}$ creates a current that must return to ground (the return of the input supply) to complete its loop. This current may flow through the body diode of the internal low-side MOSFET and the inductor to return to ground. Flowing through the body diode pulls the VOUT pin below IC ground, which violates its absolute maximum rating. Such a condition may damage the TPS62136 device and is not recommended. For protective measure, a Schottky diode must be installed on the output, as the schematic in [Figure 2](#) shows.

To avoid excessive inrush current, a soft-start capacitor is installed on the SS/TR pin.

2.2.4 Maximum Output Current

In the inverting buck-boost topology, the maximum output current is reduced as compared to the buck topology. This reduction is a result of the peak inductor current being higher, as calculated in [Equation 4](#).

For example, for an output voltage of -12 V , $1.5\text{-}\mu\text{H}$ inductor, and input voltage of 3.3 V , the following calculations produce the maximum allowable output current that can be ensured based on the TPS62136 minimum current limit value of 4.8 A . Due to increased duty cycles when operating at high load current, the duty cycle used for the following maximum output current calculation in [Equation 5](#) must be increased by 5% for these conditions, which provides a more accurate maximum output current calculation.

$$D = \frac{V_{\text{OUT}}}{V_{\text{OUT}} - V_{\text{IN}}} \times 1.05 = \frac{-12}{-12 - 1.33} \times 1.05 = 0.82 \quad (5)$$

The switching frequency at maximum load is based on [Figure 9](#). Based on the inductor data sheet, the effective inductance value is approximately $1.1\text{ }\mu\text{H}$ at 3-A current (see [Equation 6](#)).

$$\Delta I_L = \frac{V_{\text{IN}} \times D}{f_s \times L} = \frac{3.3 \times 0.82}{0.55 \text{ MHz} \times 1.1 \mu\text{H}} = 4.5 \text{ A} \quad (6)$$

Rearranging [Equation 4](#) and setting $I_{L(\text{max})}$ equal to the minimum value of $I_{L(\text{LIMF})}$, as specified in the data sheet, results in [Equation 7](#):

$$I_{L(\text{avg})} = I_{L(\text{max})} - \frac{\Delta I_L}{2} = 4.8 - \frac{4.5}{2} = 2.5 \text{ A} \quad (7)$$

This result is then used in 式 1 to calculate the maximum achievable output current in 式 8:

$$I_{\text{OUT}} = I_{L(\text{avg})} \times (1 - D) = 2.5 \text{ A} \times (1 - 0.82) = 450 \text{ mA} \quad (8)$$

図 4 shows the maximum output current for the TIDA-01423 design.



図 4. Maximum Output Current ($V_{\text{OUT}} = -12 \text{ V}$)

2.2.5 Thermal Limits

With different conditions, thermal limits may become an issue as a result of the small size of the converter itself. As the output current increases, the absolute power loss (in mW) in the TPS62136 device also increases, which causes a higher temperature rise across the thermal impedance of the TPS62136 device.

The maximum allowed IC junction temperature is 125°C as stated in the TPS62136 data sheet. To calculate the IC temperature for different conditions, multiply the power loss of the TPS62136 device by the θ_{JA} , which is approximately 40°C/W for the TIDA-01423 printed-circuit board (PCB), and add this value to the ambient temperature.

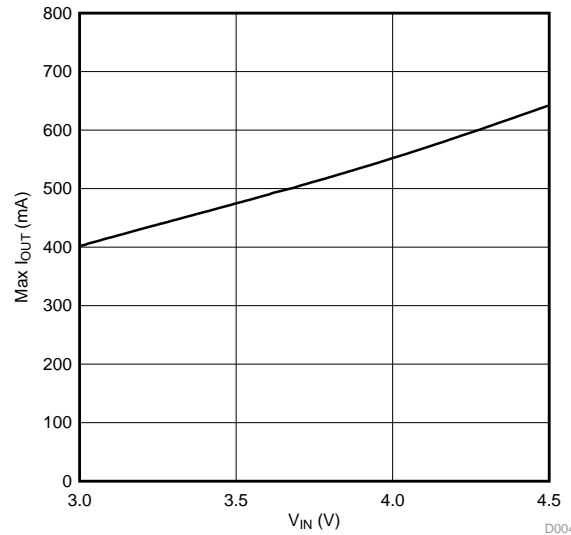
To calculate the maximum output current at any ambient temperature, simply subtract the maximum ambient temperature from 125°C to obtain the allowable temperature rise. Divide the θ_{JA} of the PCB by this temperature rise to obtain the allowable IC power loss. Find this IC power loss for an input voltage of 3.3 V in 図 8 to determine the maximum output current under specific conditions. See 式 9 for the calculation.

$$IC_{\text{Loss}} \leq \frac{125 - T_{A_MAX}}{\theta_{JA}} \quad (9)$$

2.2.6 Enable Pin Configuration

The device is enabled when the voltage at the EN pin trips its threshold and the input voltage is above the undervoltage lockout (UVLO) threshold. The TPS62136 device stops operation when the voltage on the EN pin falls below its threshold or the input voltage falls below the UVLO threshold.

Because V_{OUT} is the IC ground in this configuration, the EN pin must be referenced to V_{OUT} instead of ground. In the buck configuration, 0.83 V is considered as high and less than 0.67 V is considered as low. However, in the inverting buck-boost configuration, the V_{OUT} voltage is the reference; therefore, the high threshold is $0.83\text{ V} + V_{OUT}$ and the low threshold is $0.67\text{ V} + V_{OUT}$. For example, if $V_{OUT} = -12\text{ V}$, then V_{EN} is considered at a high level for voltages above -11.17 V and a low level for voltages below -11.24 V .

This behavior can cause difficulties when enabling or disabling the part because, in some applications, the IC that provides the EN signal may not be able to produce negative voltages. The level-shifter circuit that [Figure 5](#) shows alleviates any difficulties associated with the offset EN threshold voltages by eliminating the requirement for negative EN signals. If disabling the TPS62136 is not desired, the EN pin may be directly connected to V_{IN} without this circuit.

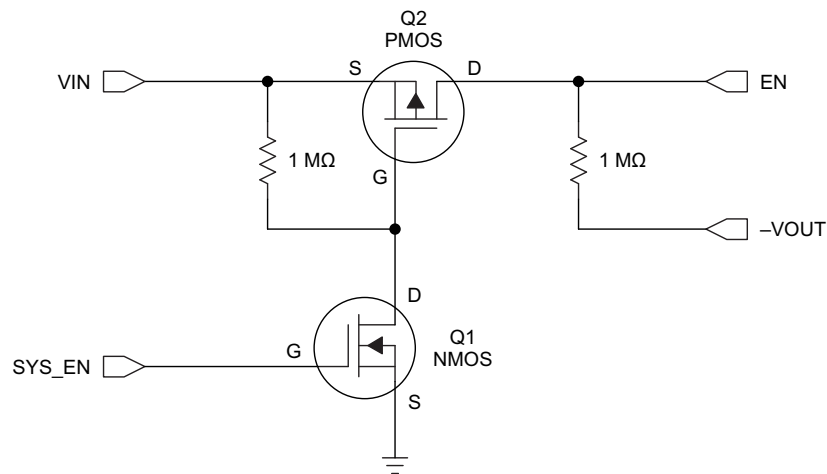

NOTE: V_{OUT} is the negative output voltage of the inverting buck-boost converter.

Figure 5. EN Pin Level Shifter

The positive signal that originally drives EN is instead tied to the gate of Q1 (SYS_EN). When Q1 is OFF (SYS_EN grounded), Q2 has 0 V across its V_{GS} and also remains OFF. In this state, the EN pin is at -12 V , which is below the low-level threshold, and disables the device.

When SYS_EN provides enough positive voltage to turn Q1 ON (V_{GS} threshold as specified in the MOSFET data sheet), the gate of Q2 is at ground potential through Q1. This action drives the V_{GS} of Q2 negative and turns Q2 ON. Then V_{IN} ties to EN through Q2 and the pin is above the high-level threshold, which turns the device ON. Be careful to ensure that the V_{GD} and V_{GS} of Q2 remain within the MOSFET ratings during both the enabled and disabled states. Failing to adhere to this constraint can result in damaged MOSFETs.

[Figure 16](#) shows the enable sequence where the SYS_EN signal activates the enable circuit. This circuit has been tested with a 3.3-V SYS_EN signal and dual N/PFET Si1029X. The EN signal is the output of the circuit and goes from V_{IN} to V_{OUT} to properly enable and disable the device.

2.2.7 Mode Pin Configuration

The operation mode can be selected with the mode pin of the TPS62136. The device runs in automatic PFM or PWM mode when this pin is pulled low (IC ground which is $-V_{OUT}$), which results in a higher efficiency at a light load. When the pin is pulled high (V_{IN}), the device runs in forced PWM mode (for a constant frequency at a light load).

2.2.8 Power Good Pin Configuration

The TPS62136 has a built-in power good (PG) function to indicate whether the output voltage has reached its appropriate level or not. The PG pin is an open-drain output that requires a pullup resistor. Because V_{OUT} is the IC ground in this configuration, the PG pin is referenced to V_{OUT} instead of ground, which means that the TPS62136 device pulls PG to V_{OUT} when it is low.

This behavior can cause difficulties in reading the state of the PG pin because, in some applications, the IC that detects the voltage level of the PG pin may not be able to withstand negative voltages. The level-shifter circuit shown in [Figure 6](#) alleviates any difficulties associated with the offset PG pin voltages by eliminating the negative output signals of the PG pin. If the PG pin functionality is not required, it may be left floating or connected to V_{OUT} without this circuit.

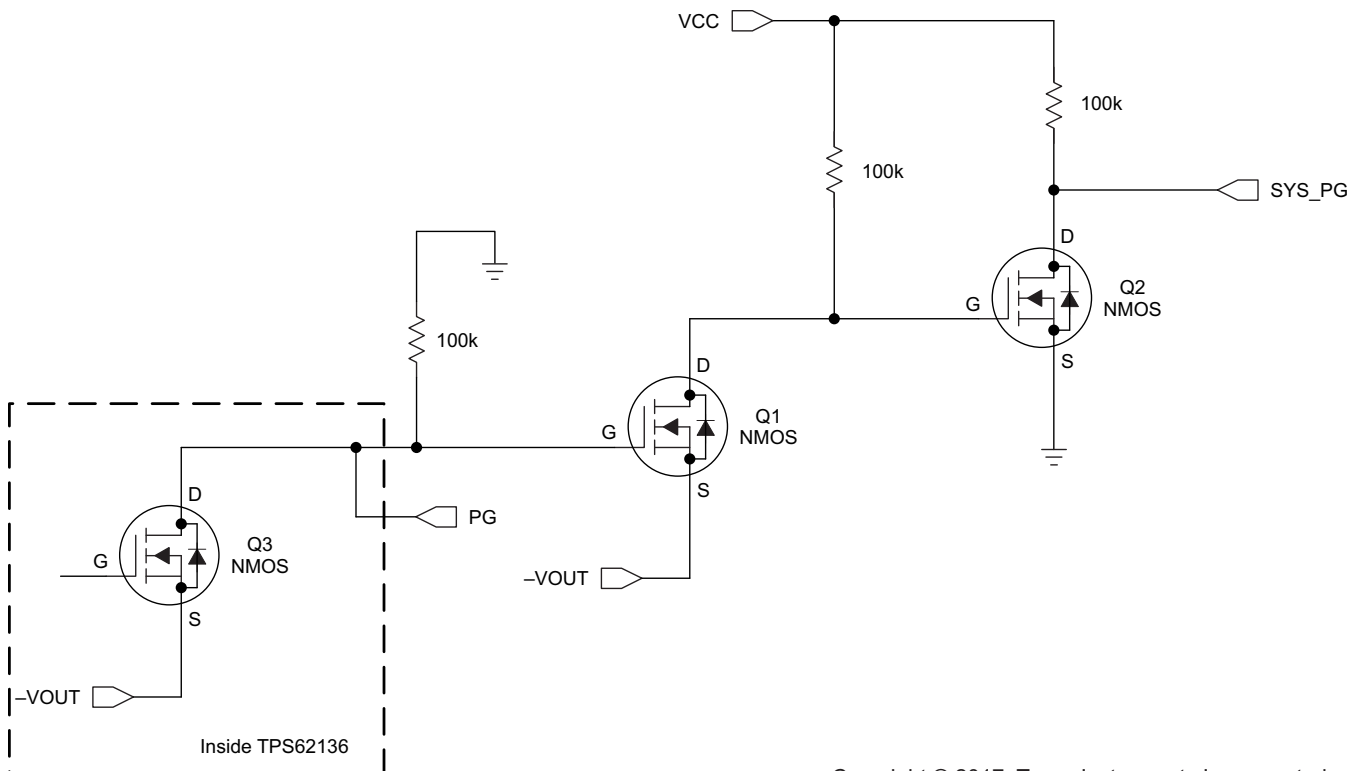

Copyright © 2017, Texas Instruments Incorporated

Figure 6. PG Pin Level Shifter

Inside the TPS62136, the PG pin is connected to an N-channel MOSFET (Q3). By tying the PG pin to the gate of Q1, when the PG pin is pulled low, Q1 is OFF and Q2 is ON because the V_{GS} of Q2 is at V_{CC} . SYS_PG is then pulled to ground.

When Q3 turns OFF, the gate of Q1 is pulled to ground potential, which turns Q1 ON. This sequence of events pulls the gate of Q2 below ground, which turns it OFF. SYS_PG is then pulled up to the V_{CC} voltage. Note that the V_{CC} voltage must be at an appropriate logic level for the circuitry connected to the SYS_PG net.

3 Getting Started Hardware

To test this TI Design, simply apply an input voltage on the J1 connector and the load to J2 connector. Then, connect a jumper between ON and EN on JP1. Set JP2 to the desired operating mode, PFM (for higher efficiency at light load) or PWM (for constant frequency at light load).

4 Testing and Results

All data in this section has been recorded using a 3.3-V V_{IN} , -12-V V_{OUT} unless otherwise noted.

4.1 Test Results



図 7. Thermal Performance (250-mA Load)



図 8. Efficiency Over Load (Mode = PFM)

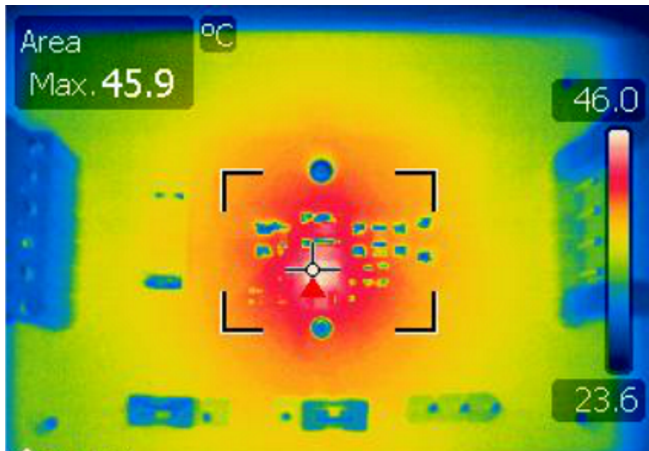

図 9. Switching Frequency Over Load

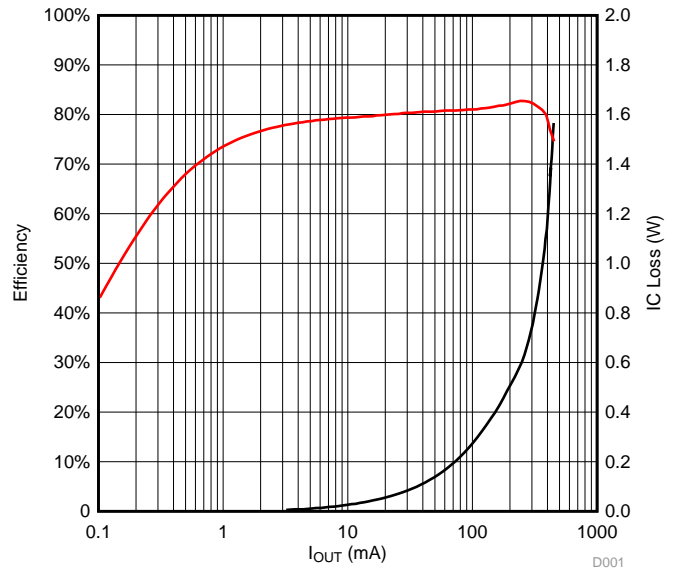

図 10. Load Regulation (Mode = PFM)

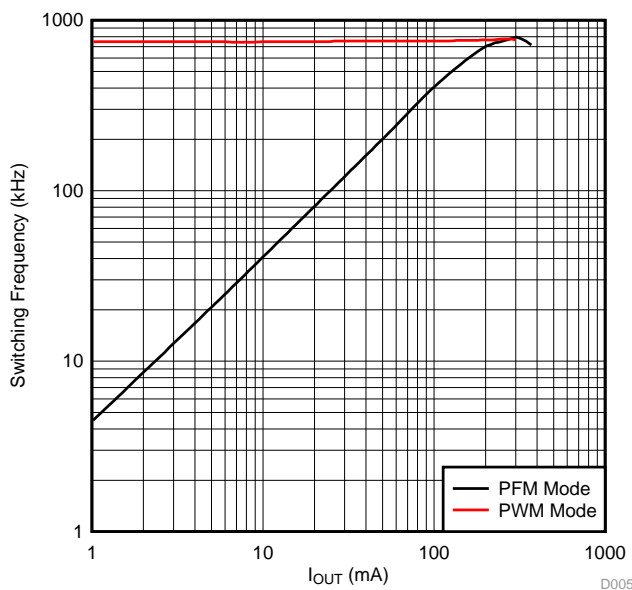

図 11. Loop Gain (300 mA)

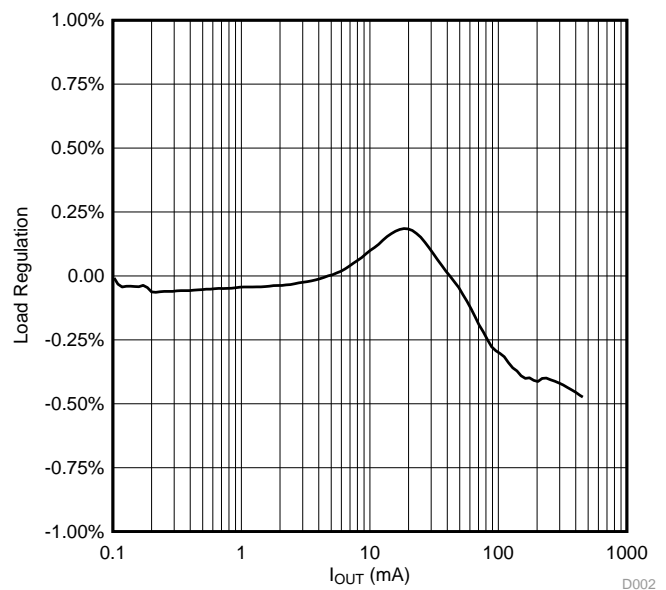

図 12. Transient Response (0-A to 250-mA Load Step, Mode = PWM)

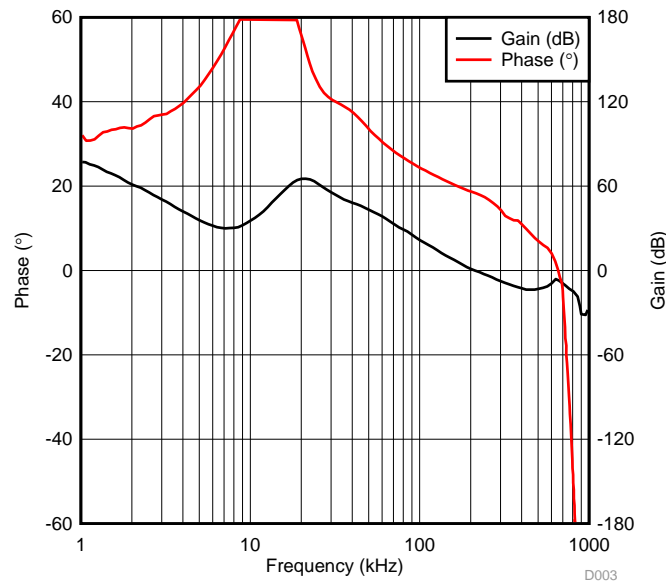

図 13. Output Voltage Ripple (1-mA Load, Mode = PFM)

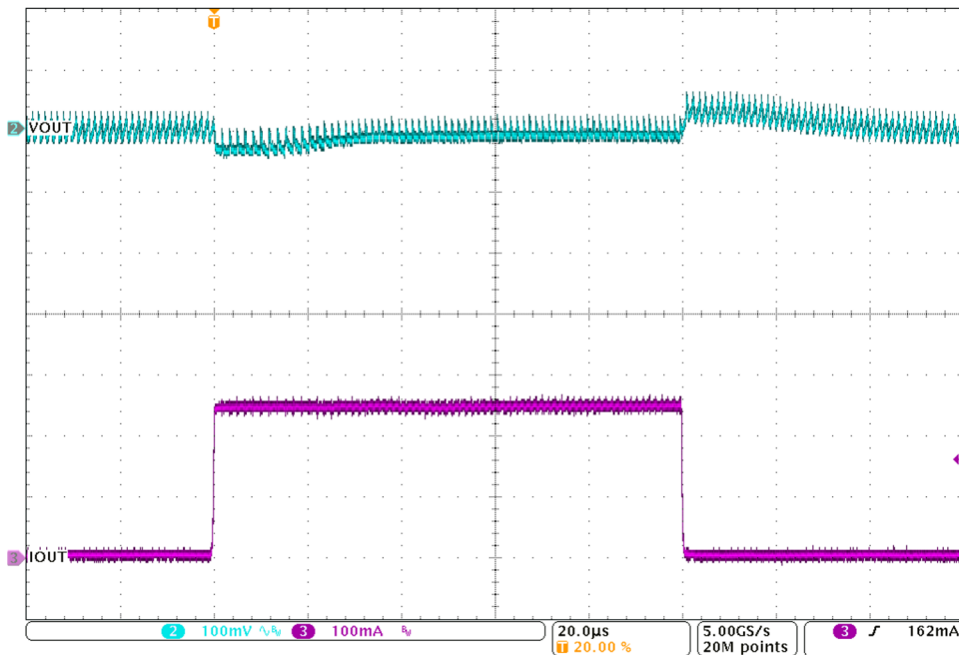

図 14. Output Voltage Ripple (1-mA Load, Mode = PWM)

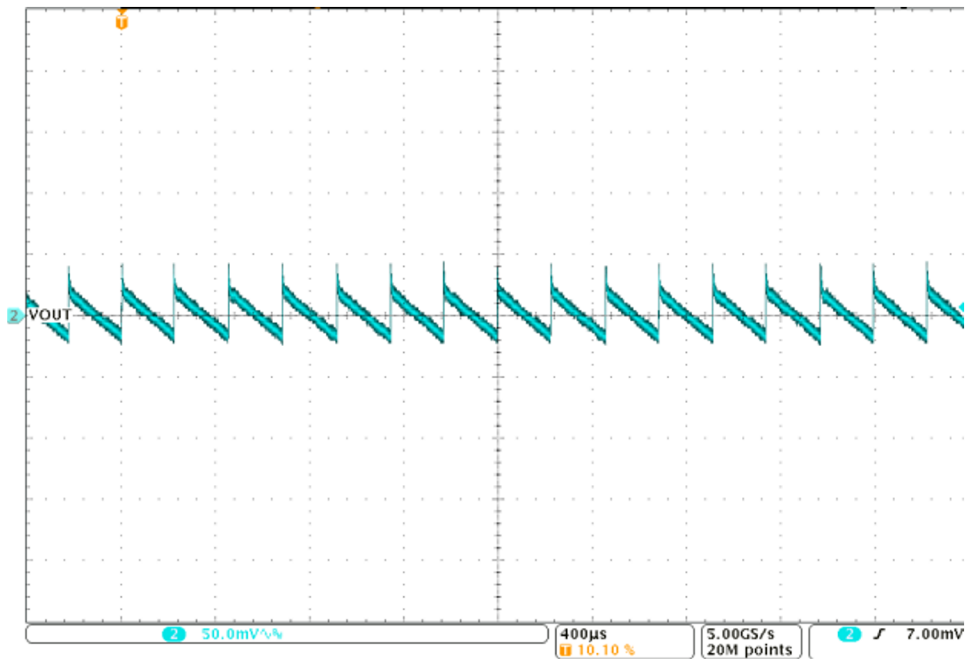

図 15. Output Voltage Ripple (250-mA Load)

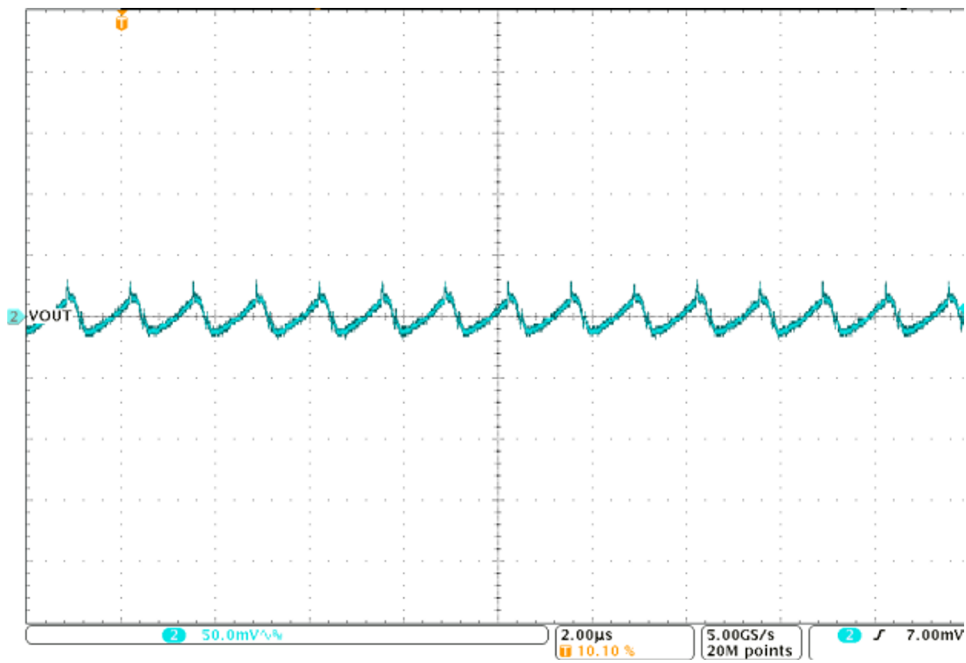

図 16. Start-Up on EN (No Load)

5 Design Files

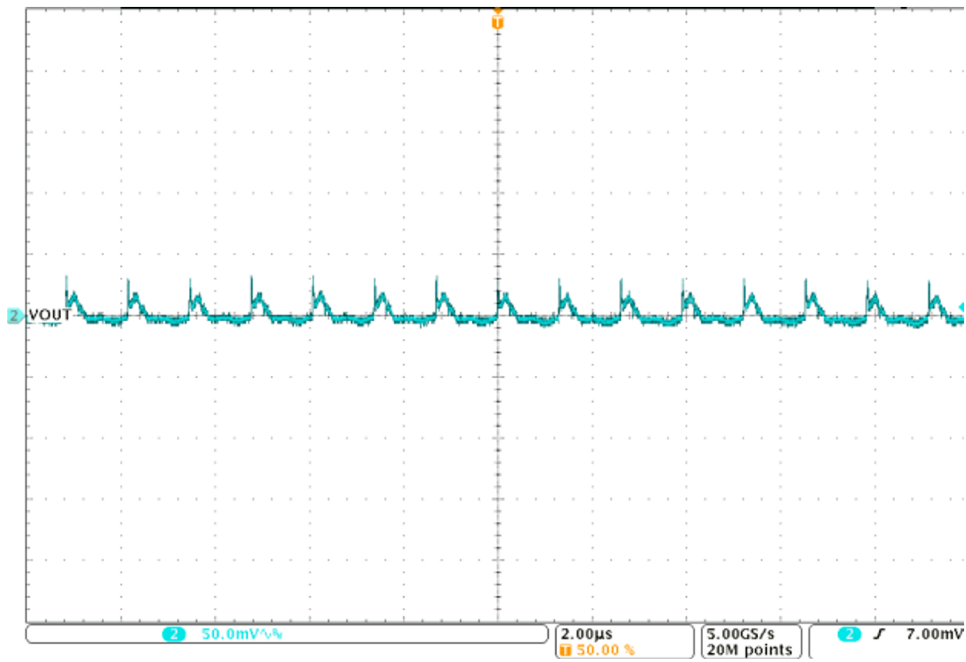
5.1 Schematics

To download the schematics, see the design files at [TIDA-01423](#).

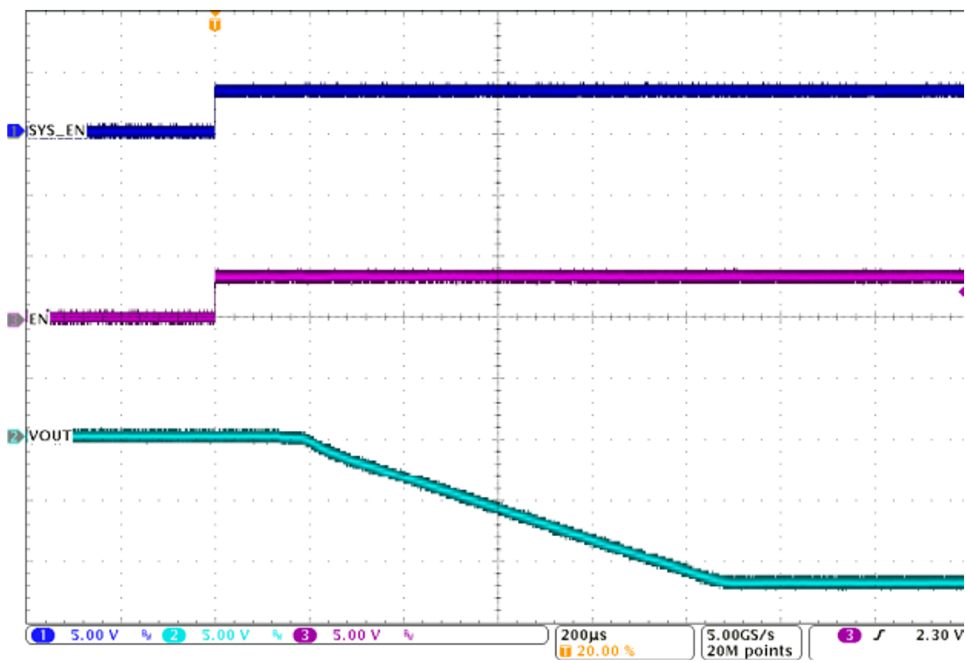
5.2 Bill of Materials

To download the bill of materials (BOM), see the design files at [TIDA-01423](#).

5.3 PCB Layout Recommendations

5.3.1 Layout Prints

To download the layer plots, see the design files at [TIDA-01423](#).

5.4 Gerber Files

To download the Gerber files, see the design files at [TIDA-01423](#).

5.5 Assembly Drawings

To download the assembly drawings, see the design files at [TIDA-01423](#).

6 Related Documentation

1. Texas Instruments, [Simplifying Stability Checks](#), Application Report (SLVA381)
2. Texas Instruments, [Using the TPS62125 in an Inverting Buck-Boost Topology](#), TPS62125 Application Report (SLVA514)
3. Texas Instruments, [TPS62136 1-MHz High Accuracy 3-V to 17-V 4-A Step-Down Converter](#), TPS62136 Data Sheet (SLVSDV2)

6.1 商標

All trademarks are the property of their respective owners.

TIの設計情報およびリソースに関する重要な注意事項

Texas Instruments Incorporated ("TI")の技術、アプリケーションその他設計に関する助言、サービスまたは情報は、TI製品を組み込んだアプリケーションを開発する設計者に役立つことを目的として提供するものです。これにはリファレンス設計や、評価モジュールに関する資料が含まれますが、これらに限られません。以下、これらを総称して「TIリソース」と呼びます。いかなる方法であっても、TIリソースのいずれかをダウンロード、アクセス、または使用した場合、お客様(個人、または会社を代表している場合にはお客様の会社)は、これらのリソースをここに記載された目的にのみ使用し、この注意事項の条項に従うことに合意したものとします。

TIによるTIリソースの提供は、TI製品に対する該当の発行済み保証事項または免責事項を拡張またはいかなる形でも変更するものではなく、これらのTIリソースを提供することによって、TIにはいかなる追加義務も責任も発生しないものとします。TIは、自社のTIリソースに訂正、拡張、改良、およびその他の変更を加える権利を留保します。

お客様は、自らのアプリケーションの設計において、ご自身が独自に分析、評価、判断を行う責任がお客様にあり、お客様のアプリケーション(および、お客様のアプリケーションに使用されるすべてのTI製品)の安全性、および該当するすべての規制、法、その他適用される要件への遵守を保証するすべての責任をお客様のみが負うことを理解し、合意するものとします。お客様は、自身のアプリケーションに関して、(1) 故障による危険な結果を予測し、(2) 障害とその結果を監視し、および、(3) 損害を引き起こす障害の可能性を減らし、適切な対策を行う目的で、安全策を開発し実装するために必要な、すべての技術を保持していることを表明するものとします。お客様は、TI製品を含むアプリケーションを使用または配布する前に、それらのアプリケーション、およびアプリケーションに使用されているTI製品の機能性を完全にテストすることに合意するものとします。TIは、特定のTIリソース用に発行されたドキュメントで明示的に記載されているもの以外のテストを実行していません。

お客様は、個別のTIリソースにつき、当該TIリソースに記載されているTI製品を含むアプリケーションの開発に関連する目的でのみ、使用、コピー、変更することが許可されています。明示的または黙示的を問わず、禁反言の法理その他どのような理由でも、他のTIの知的所有権に対するその他のライセンスは付与されません。また、TIまたは他のいかなる第三者のテクノロジーまたは知的所有権についても、いかなるライセンスも付与されるものではありません。付与されないものには、TI製品またはサービスが使用される組み合わせ、機械、プロセスに関連する特許権、著作権、回路配置利用権、その他の知的所有権が含まれますが、これらに限られません。第三者の製品やサービスに関する、またはそれらを参照する情報は、そのような製品またはサービスを利用するライセンスを構成するものではなく、それらに対する保証または推奨を意味するものでもありません。TIリソースを使用するため、第三者の特許または他の知的所有権に基づく第三者からのライセンス、あるいはTIの特許または他の知的所有権に基づくTIからのライセンスが必要な場合があります。

TIのリソースは、それに含まれるあらゆる欠陥も含めて、「現状のまま」提供されます。TIは、TIリソースまたはその仕様に関して、明示的か暗黙的にかかわらず、他のいかなる保証または表明も行いません。これには、正確性または完全性、権原、続発性の障害に関する保証、および商品性、特定目的への適合性、第三者の知的所有権の非侵害に対する黙示的保証が含まれますが、これらに限られません。

TIは、いかなる苦情に対しても、お客様への弁済または補償を行う義務はなく、行わないものとします。これには、任意の製品の組み合わせに関連する、またはそれらに基づく侵害の請求も含まれますが、これらに限られず、またその事実についてTIリソースまたは他の場所に記載されているか否かを問わないものとします。いかなる場合も、TIリソースまたはその使用に関連して、またはそれらにより発生した、実際の、直接的、特別、付随的、間接的、懲罰的、偶発的、または、結果的な損害について、そのような損害の可能性についてTIが知らされていたかどうかにかかわらず、TIは責任を負わないものとします。

お客様は、この注意事項の条件および条項に従わなかったために発生した、いかなる損害、コスト、損失、責任からも、TIおよびその代表者を完全に免責するものとします。

この注意事項はTIリソースに適用されます。特定の種類の資料、TI製品、およびサービスの使用および購入については、追加条項が適用されます。これには、半導体製品(<http://www.ti.com/sc/docs/stdterms.htm>)、評価モジュール、およびサンプル(<http://www.ti.com/sc/docs/sampterm.htm>)についてのTIの標準条項が含まれますが、これらに限られません。